

Agregat pompowy OPA.0.12

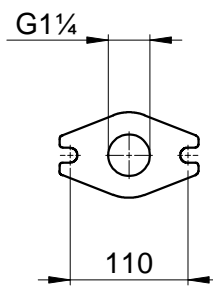

Widok „W”

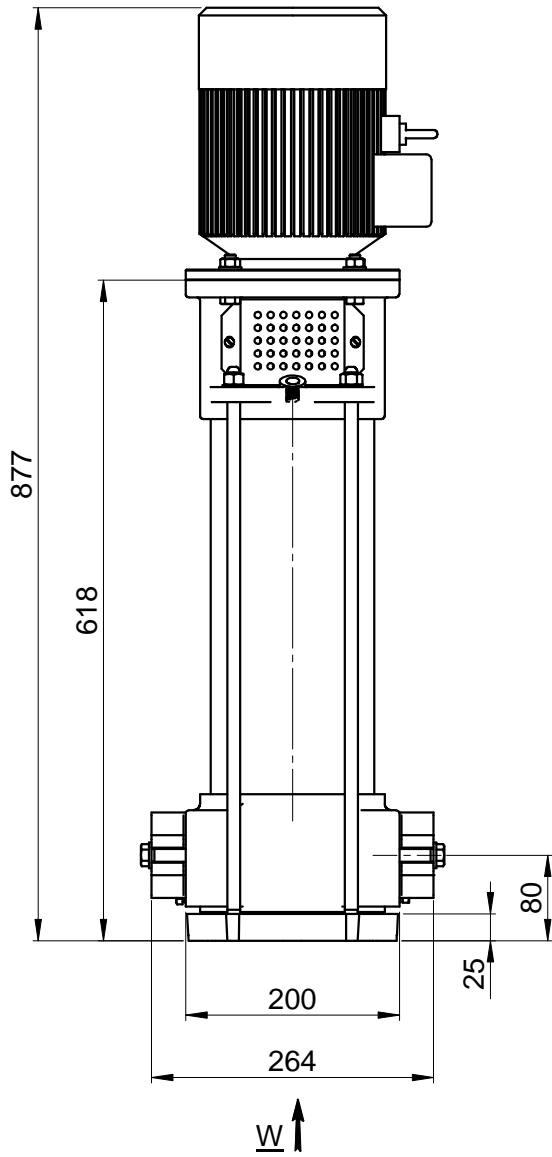